

AST-900A

---

**The Fastest, Healthiest and  
Most Convenient Way of Cooking...**

***COOK  
THE  
TURBO  
WAY***

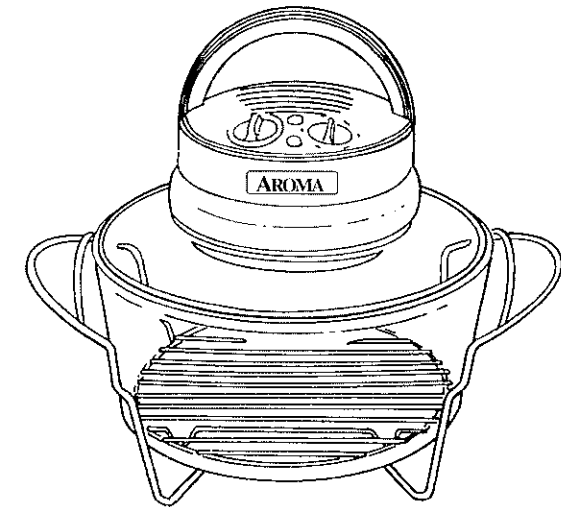

HOUSEHOLD USE ONLY  
[www.aromaco.com](http://www.aromaco.com)

**For AROMA™ AeroMatic Oven™**

---

*About the AeroMatic Oven™ and Recipes*

---

# ***COOK THE TURBO WAY***

---

Copyright 1991 by AROMA HOUSEWARES COMPANY

***Combined and Edited by:***

*Peter C. Y. Chang, D.B.A.*

***Published by:***

*AROMA HOUSEWARES COMPANY*

*6469 Flanders Drive*

*San Diego, Ca. 92121 U.S.A.*

---



## IMPORTANT NOTICE

**\*\* Please Read Before Use \*\***

1. This product is equipped with SAFETY POWER SWITCH:

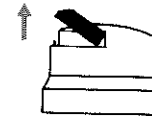

Handle lift-up: POWER OFF



Handle push-down: POWER ON

2. When inserting power cord to the head unit, please push in firmly to ensure the attachment.

3. While the first using, there may be smell of lubricant appeared from the top unit. The smell usually will be disappeared after 10 minutes of use.

ANY QUESTION PLEASE CALL (619)558-6688 AROMA HOUSEWARES CO.  
CUSTOMER SERVICE DEPT.

## TABLE OF CONTENTS

<b>IMPORTANT SAFEGUARDS</b> .....	1
<b>AeroMatic Oven™</b>	
WHAT IS AN AeroMatic Oven™? .....	7
HOW DOES IT OPERATE? .....	7
HOW DOES THE AeroMatic Oven™ LOOK LIKE? .....	8
AeroMatic Oven™ SPECIFICATIONS .....	9
HOW TO USE LOW AND HIGH RACKS? .....	10
WHY IS THE AeroMatic Oven™ ALSO CALLED "LOW -CHOLESTEROL, LOW-FAT OVEN?" .....	10
HOW DO I CLEAN MY AeroMatic Oven™? .....	10
WHAT METHODS OF COOKING CAN BE USED? .....	11
ADVANTAGES OF THE AeroMatic Oven™ .....	11
FUNCTIONS OF THE AeroMatic Oven™ .....	13
 <b>TURBO-BAKING AND STEAMING</b>	
HELPFUL HINTS .....	14
RECIPES .....	16
 <b>TURBO-BROILING AND GRILLING</b>	
HELPFUL HINTS .....	32
RECIPES .....	33
 <b>TURBO-ROASTING</b>	
HELPFUL HINTS .....	45
RECIPES .....	46
AeroMatic Oven™ AS A TOASTER AND WARMER .....	50
 <b>TURBO-FRYING</b>	
ADVANTAGES .....	52
GUIDELINES IN PROPER AeroMatic Oven™ FRYING .....	53
RECIPES .....	54
 <b>COOKING FROZEN FOODS</b> .....	56

## IMPORTANT SAFEGUARDS:

**When using your AeroMatic™ Oven, basic safety precautions should always be followed including the following:**

1. Read all instructions.
2. Do not touch hot surface. Use handles or knobs.
3. To protect against electrical shock do not immerse cord, plugs or top unit in water or other liquid.
4. Close supervision is necessary when any appliance is used by or near children.
5. Unplug from outlet when not in use and before cleaning. Allow to cool before putting on or taking off parts.
6. Do not operate any appliance with a damage cord or plug or after the appliance malfunctions, or has been damaged in any manner. Return appliance to the nearest authorized service facility for examination, repair, or adjustment.
7. The use of accessory attachments not recommended by the appliance manufacturer may cause injuries.

8. Do not use outdoors.
9. Do not let cord hang over the edge of the table or counter, or touch hot surfaces.
10. Do not place on or near a hot gas or electric burner, or in other heated oven.
11. Extreme caution must be used when moving an appliance containing hot oil or other liquids.
12. Always attach plug to appliance first, then plug cord into the wall outlet. To disconnect, turn any control to "off" then remove plug from wall outlet.
13. Do not use appliance for other intended use.
14. When moving the top unit, always use the metal rack for placing the top unit.
15. When not in use, the handle should be lifted up in the OFF position and the unit unplugged.
16. Do not use glass pot for other purpose or cook foods on fire.
17. Do not clean glass pot or top unit when they are hot.

## SAVE THESE INSTRUCTIONS:

These units are "For Household Use Only".

### PARTS IDENTIFICATION

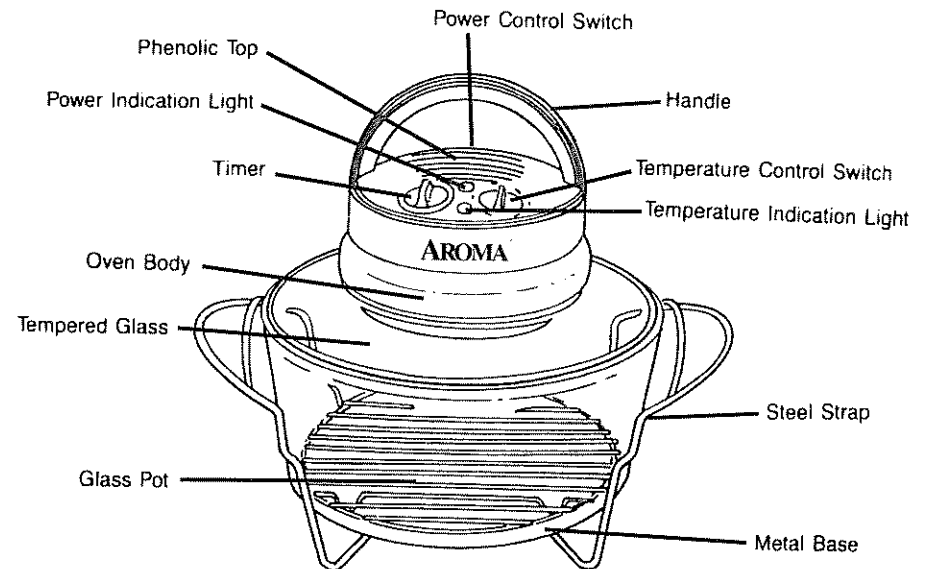

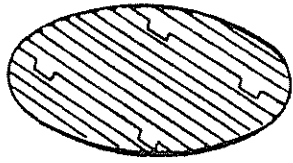

Low Rack  
(For food cooking)

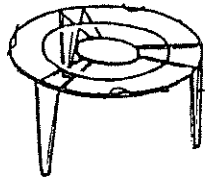

High Rack  
(For placing oven top)

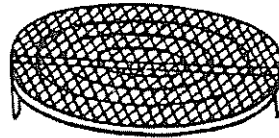

Screen Rack  
(For small pc. of food)

## OPERATIONS:

1. Place the rack in the glass container and then put the food on the center of the rack. Allow 3 inch space between food and top of the oven. (Fig. 1)
2. Put the oven on the glass-container securely. (Fig. 2)
3. Insert the plug to the socket, then the timer to an expected time. When you set the timer, the power light will be turned on and the motor starts to turn the heated air in the glass container. (Fig. 3)
4. Turn the temperature switch to an expected temperature, then the temperature light will hbe turned on and cooking starts. (The blinking of temperature indication light means the temperature is being adjusted automatically.) (Fig. 4)

5. When cooking time is up, the power will be turned off automatically. (Fig. 5)
6. When the handle lifts up, power turns off. To turn on power, push down the handle. (Fig. 6)

FIG. 1

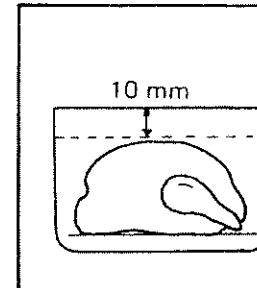

FIG. 4

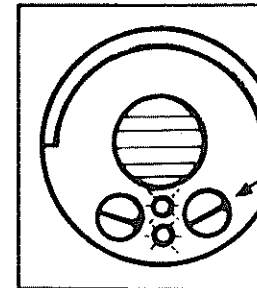

FIG. 2

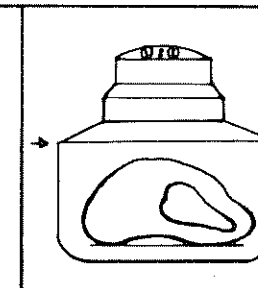

FIG. 5

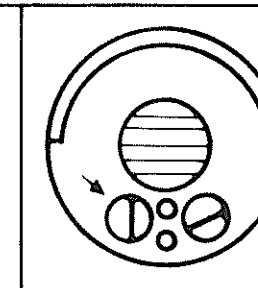

FIG. 3

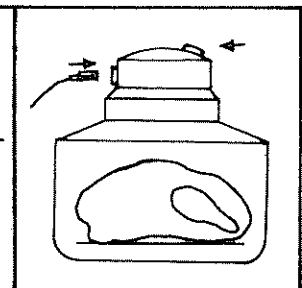
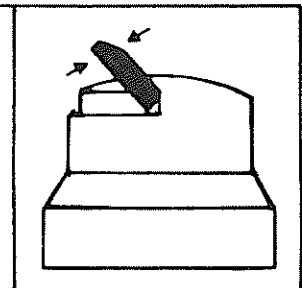

FIG. 6



## CLEANING:

1. After used, don't wash the glass container immediately. Wash it after it is cool. (Fig. 11)

2. Don't wash the oven in water or polish it with any dissolvent, volatile solution or any rough cleansing powder. **POLISH IT WITH MILD CLEANER.**
3. When cleaning the oven, you may take the filter apart from inside of the oven by taking out the 3 connecting nuts. This should be done when the unit unplugged and the oven is in cold status. (Fig. 12)
4. Never immerse the top unit in water.

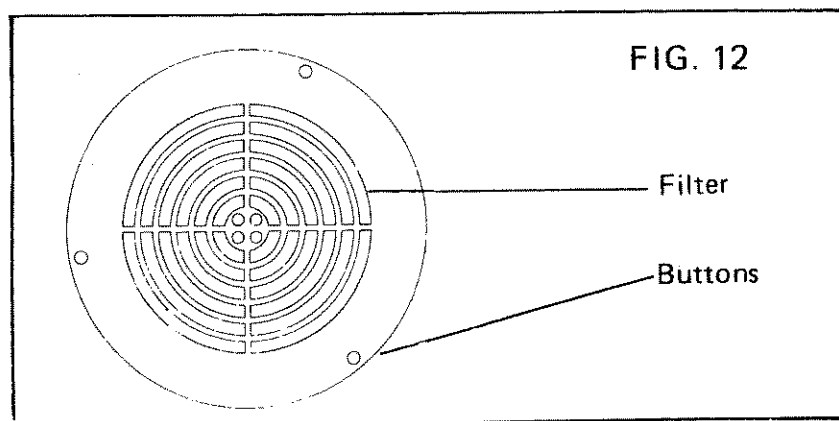
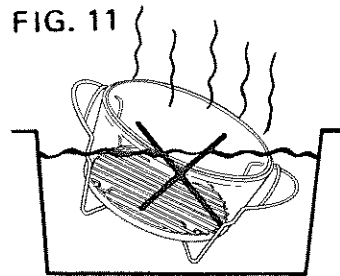

## AeroMatic Oven™ COOKING

### 1. WHAT IS AN AeroMatic Oven™?

The portable, see-through oven (otherwise known as the AROMA AeroMatic Oven) exemplifies a new trend of equipping today's kitchen! More and more people are cutting their ties to the kitchen that has traditional, full sized "fixture" appliances. They prefer to use compact, portable cookers like this AeroMatic Oven because it is faster and energy-efficient. It allows you to prepare your food wherever it is most convenient on a coffee table, in an office, or a college dorm, even without normal kitchen facilities. The Aroma table-top AeroMatic Oven allows you to observe cooking through its large, tempered-glass pot. The built-in timer assures cooking perfection and eliminates the possibility of burnt food.

### 2. HOW DOES IT OPERATE?

By cooking the "TURBO" way, all you need is an electric outlet. Made of a filter, a built-in exhaust fan and a heating element, the AeroMatic Oven cooks food by turbinating hot air which revolves around the meat or produce it cooks. With space provided around all sides and under the rack, food cooks uniformly and does not sit in its own juices. The diagram on next page shows the air movement with arrows.

When placing food on the rack, be sure to allow space between the food and the filter of the heating unit filter on the top.

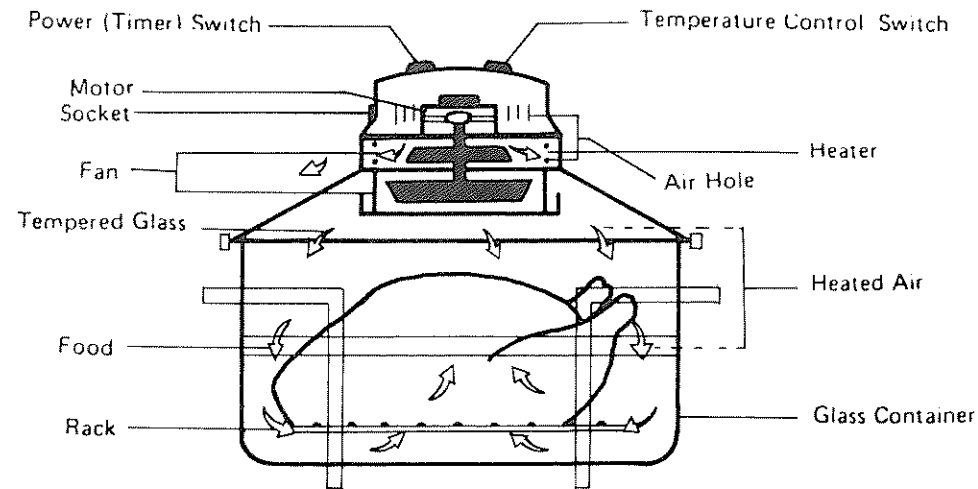

To cook properly, the top unit (which propels the heated air) must be set on the pot tightly. This conserve the heat and provides for correct convection air flow. If the top does not seat correctly, cooking time will be longer and there will be a vibrating noise.

### 3. AeroMatic Oven™ SPECIFICATIONS

#### TOP HEATING UNIT AND COVER:

- a. The top heating unit is available for 110/ 120V (USA) or for 220/240V (Asia/Europe).
- b. The timer switch may be set for up to 60 minutes. The temperature knob(which is thermostatically controlled) operates up to 500 deg.F. The readings are also gives in equivalent centigrade.
- c. Underneath the "turbo-fan" is a grease filter which is easily removed with screws for cleaning.
- d. Dimensions of top unit and cover (rounded figures):  
12 1/2 in. diameter x 8 inches high
- e. The unit is equipped with a micro power switch beneath the left arm of handle. When the handle is pushed down, the power turns on. Simply lift the handle straight up to turn the power off.

#### BOTTOM GLASS POT:

The see-through glass pot is 12 inches in diameter and stands 7 inches high without the holder. The model includes a metal holder and stand to protect table surfaces.



#### 4. HOW TO USE THE LOW AND HIGH RACKS?

The recipes in this book were all tested using the low rack. Should you prefer your food cooked more crispy or brown, you may use high rack for cooking. (The other high rack provided with the oven is designed to rest the oven head top on after use to protect counter tops.)

#### 5. WHY IS THE AeroMatic Oven™ ALSO CALLED A "LOW-CHOLESTEROL, LOW-FAT OVEN?"

You can turbo-fry eggrolls, french fries and the like with little or no cooking oil as compared to the usual deep-fat frying method.

#### 6. HOW DO I CLEAN MY AeroMatic Oven™?

Just like any other electrical appliance, the instruction manual gives helpful hints on the proper use and care of your oven. **BE SURE TO READ THE MANUAL CAREFULLY!** One advantage of the AeroMatic Oven is ease of cleaning. **NEVER IMMERSER THE TOP UNIT IN WATER!** Just wipe inside and outside with a warm damp cloth. The grease filter can be removed and soaked if needed in hot detergent. **AVOID SOAKING THE HOT GLASS POT** in cold water. Wait for it to cool before cleaning. Do not use abrasive cloth nor cleanser on glass. If necessary just pour 1/2 inch of water and some detergent into the AeroMatic Oven glass pot. Replace the top oven and set thermostat to 200 deg.F and time switch for 15 minutes. You can watch as the amazing self-cleaning turbo action softens and removes the soil residues.

#### 7. SPEAKING OF VERSALITY... WHAT METHODS OF COOKING CAN BE USED WITH THE AeroMatic Oven™?

This appliance is multi-purpose: it can broil, roast, steam, grill, toast, bake and even fry. **EACH OF THESE METHODS IS DISCUSSED IN SUCCEEDING PAGES. HELPFUL HINTS ARE GIVEN FOR EFFICIENT USE OF THE SET.** It can also thaw out foods like a microwave oven. Often times, the frozen product can be cooked directly without thawing.

#### 8. WHAT ARE THE OVERALL ADVANTAGES OF THE AeroMatic Oven™?

- a. Energy-saving: saves electricity and cooking time.
- b. Easy and safe to operate. No need to preheat!
- c. Food quality is excellent: done inside, uniformly cooked and crispy outside yet moist and juicy inside.
- d. Healthy way of cooking. Retains nutrients and at the same time drain excess undesirable fat and cholesterol.
- e. Turbo-frying has the result effect of fried foods with very little cooking oil used.
- f. Foods need not be turned or stirred for even cooking.
- g. Cooking in progress is visible, and no burned foods because of the timer.

- h. Easy to clean and maintain.
- i. Inexpensive and portable.
- j. Just right for small families (from 1 to 4 members).
- k. Excellent for thawing out, warming up and reheating.
- l. Serving portions of foods with different seasonings can be cooked at the same time on the rack WITHOUT THE FLAVOR OF ONE CONTAMINATING THE OTHER. For example: in a family of 4; the father may be on a low sodium diet, and his steak or chop has salt- substitute or low sodium spices. His son likes hot, spicy seasonings and his wife is on a bland diet without peppers, etc. The daughter adds her own spices as she pleases. All four meat pieces are cooked at the same time without intermingling of the flavors/seasonings. If a rare steak is desired, the lid may be opened to remove one piece. In my family, foods cooked in the turbo-broiler are always served hot. We can split one piece of fish/steak or chop, roast, etc. and continue to cook the rest while we eat hot foods hot.
- m. Different kinds of food items may be cooked on the same rack although at a varying no. of minutes. For example, for breakfast: 2 muffins, 2 biscuits, 2 croissants. Or for lunch: a hamburger, 2 hotdogs, and broiled fish fillet.
- n. Can be used as a "slow cooker" for stews and as a mini "incubator" when letting yeast dough rise or for final proofing.

### 9. WHAT ARE THE FUNCTIONS OF AeroMatic Oven™ AS COMPARED WITH THE CONVENTIONAL AND MICROWAVE OVENS?

FEATURES	AeroMatic	CONVENTIONAL	MICROWAVE
Portable	Yes	No	Hard
Watch food cooking	Yes	Hard	Hard
Fast cooking	Yes	No	Yes
Save energy	Yes	No	Yes
Browns and crisps	Yes	Yes	No
No smoke	Yes	No	Yes
Grills	Yes	Yes	No
Bakes	Yes	Yes	Yes
Easy to clean	Yes	No	Yes
Microwave radiation	No	No	Yes
Juicy foods	Yes	Not always	Usually
Uniform cooking	Yes	Yes	No
Adjustable temp.	Yes	Yes	No
Reduces fats	Yes	Some	No

## A. TURBO-BAKING AND STEAMING:

### HELPFUL HINTS

For uncovered dishes, the temperature of cooking is from 25 to 50 deg.F lower for turbo-baking. NO PRE-HEATING IS NECESSARY IN TURBO-BAKING. Use the glass pot to observe the cooking endpoint and be sure to record the actual cooking time for future use.

Be sure to use containers that will fit the diameter or length of your bottom pot. One can easily form from 2 layers of heavy duty-aluminum foil the desired size/shape of baking pans. Usually, the middle part of a cake batter is still moist while the portions nearer the rim will be done. To remedy this, a tube-pan or bundt cake pan is better to use than the layered bigger cake pans. Also, the disposable aluminum foil mini-loaf pans cook faster and more evenly. Muffin-welled pans for cupcakes or individual muffins (4 or 6 wells) lined with fluted paper cups or Teflon lined pans are excellent for small batches.

For a family of 2 to 4 and especially for single member households, TURBO-BAKING IS SPEEDY, CHEAPER, CONVENIENT AND FOOD IS OF EXCELLENT QUALITY! USE READY MIXES OR CONVENIENT FOOD ITEMS THAT ARE JUST OF THE RIGHT AMOUNT FOR YOUR NEEDS.

\* If there are leftovers, freeze quickly and reheat later while still frozen using your AeroMatic Oven.

## BAKING: HOW THE AeroMatic Oven™ SAVES TIME AND ENERGY (NO. OF MINUTES AND DEG.F)\*

KIND OF BAKED GOODS	CONVENTIONAL OR REGULAR OVEN	AeroMatic Oven™
	(INCLUDES PREHEATING TIME)	(NO PREHEATING TIME)
Biscuits	20 mins., 450 deg.F	10 mins., 400 deg.F
Cake, layer	35 mins., 350 deg.F	20 mins., 300 deg.F
Cake, loaf	55 mins., 325 deg.F	35 mins., 300 deg.F
Cornbread	35 mins., 425 deg.F	20 mins., 350 deg.F
Coffeecake	35 mins., 400 deg.F	20 mins., 375 deg.F
Cookies:		
drop	15 mins., 375 deg.F	8 mins., 325 deg.F
bar/brownies	35 mins., 350 deg.F	20 mins., 300 deg.F
rolled	20 mins., 375 deg.F	10 mins., 325 deg.F
Pastry/pie:		
Pie crust	20 mins., 425 deg.F	10 mins., 400 deg.F
w/ filling,		
(no top crust)	55 mins., 350 deg.F	30 mins., 325 deg.F
w/ filling,		
(two-crust)	60 mins., 425 deg.F	40 mins., 350 deg.F
w/ meringue	15 mins., 400 deg.F	8 mins., 350 deg.F
Pizza Pie	25 mins., 425 deg.F	12 mins., 400 deg.F
Yeast breads:		
Rolls	25 mins., 400 deg.F	15 mins., 350 deg.F
Loaf pan	50 mins., 375 deg.F	30 mins., 325 deg.F
Muffins	25 mins., 400 deg.F	15 mins., 350 deg.F

\*THESE ARE AVERAGE FIGURES. TIME MAY VARY ACCORDING TO SIZE or DEPTH OF MIXTURE, COMPOSITION OF INGREDIENTS & DESIRED CRISPNESS AS IN PIZZA AND COOKIES.

### MEAT LOAF WITH BACON TOPPING

2 lbs. lean ground beef  
 2 fresh eggs  
 2 tsp. garlic salt  
 1 small can tomato paste (6 oz)  
 1 cup uncooked oats (or 1 cup bread crumbs)  
 1/2 cup catsup  
 1/2 cup chopped white onions (or 2 tbsp. dry minced onions)  
 1 tsp. black pepper  
 1 tbsp. sugar  
 1 tbsp. soy sauce or Worcestershire sauce  
 Strips of bacon for topping

MIX EVERYTHING TOGETHER, except bacon slices. Grease loaf pan and pack in meat mixture 3/4 high. Top with bacon slices. Turbo-bake on low rack at 350 deg.F for one hour. Cooking time may be less if baked in two loaves (using smaller pans).

### TURKEY-HAM LOAF

Use the same proportions above except replace 2 lbs. lean ground beef with one lb. ground turkey meat and one lb. finely chopped ham. Glaze with pineapple preserve.

### BEEF POT PIE

Prepare beef stew using tested recipes on the label of beef stew seasoning mix. Thicken with flour. (Cook on top of stove for the beef stew filling).

Arrange beef stew in pie pan and cover with pie crust. There are many ready-to-use frozen pie shells or pie crust sticks which are very good and convenient. A basic pie crust recipe is also given.

Seal pie edges and prick or make slits in pie crust. Turbo-bake, setting the pie plate on low rack and cook for 20 minutes (400 deg.F). Toward the last 5 minutes, brush top with beaten egg for an appetizing golden brown crust.

### WHOLE CORNED BEEF BRISKET

Remove the curing solution in the plastic bag of the ready-to-cook corned beef brisket. Set aside in a saucepan and use the solution for cooking boiled potatoes and green cabbage, adding more water to lessen saltiness.

Place whole corned beef brisket directly on the low rack with fat side up. Bake for 1 1/2 hrs. for a 5 to 6 lb. brisket. For less saltiness, wipe surface with absorbent towel to remove excess salty solution before baking.

### INDONESIAN BEEF

1 1/2 lbs. lean beef sirloin (boneless)  
 1 clove minced garlic      1/2 tsp. cumin  
 1 1/2 tbsp. soy sauce      1/2 tsp. coriander  
 1 tbsp. vegetable oil      1/2 tbsp. salt  
 skewers

Cut beef into 3/4"-1" cubes. In a mixing bowl, combine garlic, soy, salt, oil, cumin and coriander. Add beef and stir to coat. Refrigerate for one hour.

Remove meat from marinade. Thread 4-6 pieces of meat on each skewer. Arrange skewers on rack and grill for 8- 10 minutes at 400 deg.F.

### BAKED CHICKEN (Filipino Style)

Cut chicken fryer into quarters, or use whole leg-thigh (4) pieces. Marinate in a mixture of 2 tbsp. soy sauce, 2 tbsp. dark brown sugar, 1 tsp. MSG, 1 tsp. salt, 1 tbsp. slivers of ginger root and 1/2 tsp. black pepper. Soak dried mushrooms to soften and cut the bigger pieces. After marinating for several hours, arrange chicken pieces in a baking dish or shallow pan. Add 1/2 cup mushrooms and 1 cup chestnuts. Pour over the marinade. Set casserole dish on the low rack and bake for 30 minutes (350 deg.F). For green vegetables, add sprigs of green onions.

### BRAISED/BAKED PORK CHOPS W/ SOY SAUCE

Marinate pork chops in soy sauce, lemon juice and onion salt. Bake in a shallow pan with the marinade until done. (400 deg.F, 15 minutes on a low rack). Pan-fry some onion rings and place on top of the pork chops before serving.

### BREADED BAKED PORK CHOPS

Rub surfaces of pork chops with salt and pepper. After an hour, dip in beaten egg-milk mixture and roll in bread crumbs. Arrange singly on a greased shallow pan or on a shaped heavy aluminum foil. Set on the low rack and turbo-bake at 400 deg.F for 15 minutes or until nicely brown. Turn over once to brown the other side.

### POACHED EGGS

Break an egg directly into an individual custard cup. Add salt as desired. Cover with water (about 2 tbsp.) so that yolk is protected with liquid. Use low rack. Set at 350 deg.F and cook for 5 minutes or until the desired softness.

### SOFT-COOKED EGGS

Wash eggs and place directly on low rack. For soft cooked eggs, cook at 400 deg.F for 5 minutes. For hard-cooked eggs, cook for 7 minutes. Cooking time is based on a large-sized egg that came directly from refrigerator.

COOL IMMEDIATELY UNDER RUNNING COLD WATER TO AVOID FURTHER COOKING AND TO REMOVE SHELL EASILY.

### OMELETS

Beat enough eggs (according to serving portion desired by family). Ready the glass pie pot and line the glass pot with aluminum foil for easy serving and cleaning. Grease pot or foil lightly with non-stick oil spray or use butter, margarine, cooking oil, or lard to suit your taste. Spread the seasoned beaten eggs (spices and condiments per individual likes, omitting salt if needed) and distribute fillings evenly on the eggs.

Suggested fillings for omelets:

- a. Shredded cheese (use buttered pan)
- b. Minced fresh tomatoes, green onions with white bulb
- c. Finely chopped white onions, tomatoes and crab meat
- d. Slices of ham, bell peppers, onions and tomatoes
- e. Canned corned beef or cornbeef hash
- f. Finely diced potatoes and bacon bits
- g. Left-over cold cuts (salami, lunchmeat, hot dog, sausage)
- h. Tiny shrimps or chopped shrimp meat with condiments.

- i. Vegetable omelets: choice of bamboo shoots, mushrooms, bell or sweet peppers, onions, spinach, zucchini or yellow squash, chayote (sayote), "upo" or bottle gourd, "patola" or sponge gourd, bean sprouts as in egg foo yung, etc.
- j. Ground beef or pork sauted in garlic, onions, & tomatoes

There are many variations for omelets and the method of cooking may be extended to crepes.

Use LOW RACK. Temperature may be set at 350 deg.F and length of cooking time depends on no. of eggs and volume of fillings used. For example: a 2-egg recipe with minced onions and tomatoes in a thin layer (about 1/4 in. thin) cooks at 350 deg.F for 12 mins. Cook at moderate temperature only so that edges are not browned earlier while middle part is still moist. Use glass pot so that progress of cooking is observed. Doneness will depend on thickness of mixture. If non-stick or Teflon lined pans are used, less grease is needed.

### PLAIN SWEET POTATOES

Wash unpeeled sweet potatoes of about the same size and shape. Bake whole if potatoes are small and split lengthwise if potatoes are big. For a crusty skin, do not wrap. Bake with open side facing the rack and cook for about 20 minutes at 475 deg.F (30 mins for whole potato.)

### **PLAIN WHITE POTATOES (Russet)**

Wash white potatoes: air dry before wrapping each in aluminum foil. Place on low rack and bake at 475 deg.F for about 30 minutes depending on size of potatoes. Slit aluminum foil (like a cross) to expose potato for adding the desired toppings and dressings, such as sour cream, butter, bacon bits, etc.

For a crusty skin, choose big Russet baking potatoes and split lengthwise. Rub surface with butter (on both skin and cut part). Do not wrap. Bake with cut surface facing low rack, for about 25 mins. at 475 deg.F or until done. A whole unwrapped potato about 3 inches in its middle diameter and 5 to 6 inches long may take 40 minutes to cook.

Technically speaking, the process used is broiling considering the temperature used (highest for the appliance), but when the potatoes are wrapped in foil, the baking process is in effect.

### **BAKED CLAMS OR BAY MUSSELS**

20 fresh large clams or bay mussels (or 2 doz) removed from shell and arranged on baking dish/pan, preferably tempered glassware ready to serve.

Mix together black pepper (1/2 tsp.), 2 tbsp. lemon juice, garlic salt (to taste) and chopped onions (1/4 c). Distribute on top of each shellfish and bake on low rack at 300 deg.F for about 8 minutes. Larger pieces may need 10 minutes to cook.

### **BAKED FISH FILLET OR FISH STEAK**

Fresh fish fillet may be baked using the same sauce as described above. Time of cooking varies with thickness of fillet and degree of thawed state. Bake at 300 deg.F for about 6 to 8 minutes.

### **STEAMED WHOLE FISH**

Form a baking pan for the whole fish (red snapper, mackerel, mullet, flounder, or any fleshy white fish). Season all surfaces of the fish with salt, pepper and lemon juice. Pour 1/2 cup of water in the glass pot. Wrap fish well with the foil and steam at 350 deg.F for 10 to 20 minutes, depending on size of fish. Arrange steamed fish on an oval platter with lettuce as bedding. This is a favorite fish dish for a buffet table and can be prepared ahead of time.

**BE SURE THAT FISH IS FREE OF ANY LOOSE SCALES!** Do not oversteam. Fish should be delicately tender. **JUST LIKE IN ANY FISH COOKERY, THE DELICIOUS FLAVOR AND AROMA IS MAINLY DEPENDENT ON FRESHNESS OF THE RAW FISH!**

### **ORIENTAL STEAMED FISH**

Use the same preparations and cooking process as the previous "Steamed Whole Fish" recipe. Change seasoning to:

- 2 pcs. green onion, 2" long, pounded
- 3 slices ginger root
- 1 clove garlic, crushed

- 2 tbsp. rice wine
- 1/2 tsp. salt, sprinkled on both sides

### SEA SHELL MACARONI CASSEROLE

- 2 cups precooked chicken pieces (stewed with garlic salt)
- 1 tbsp. oil
- 1/2 cup sliced onions
- 1 small can (8 oz) tomato sauce
- 1 pkg. (1.5 oz) spaghetti sauce mix
- 3 pcs. bay leaves
- 1/4 tsp. thyme and 1/4 tsp. oregano (optional)
- 1 pkg. (4 oz) shredded mozzarella cheese (or 1/2 cup)
- 1/4 cup grated or shredded cheddar cheese
- 1 small diced fresh bell pepper

#### A. On stove-top using a saucepan or skillet:

Saute chicken (or other meats desired) and onions in cooking oil. Add the tomato sauce; stir and cook for one minute. Add one cup of chicken broth before gradually stirring in the spaghetti sauce mix. Add bay leaves, thyme and oregano. Simmer gently and stir occasionally to avoid scorching 5 minutes. Use cheese and bell pepper are for toppings. Meanwhile, cook the sea shell macaroni following the directions on the package. For the above quantity of meat sauce, use a 12 oz package. This yields a 9 in. diameter by 2 inch. deep casserole dish or aluminum foil container which can be turbo-baked.

Drain cooked macaroni well. Blend with the meat sauce and place inside casserole dish.

#### B. Bake at 350 deg.F for 15 minutes uncovered, on low rack.

Top with the diced peppers and cheese. Continue to bake for five more minutes. (Or until cheese is nicely melted.) If desired, add slices of pepperoni, Italian sausage or turkey ham/sausage after sprinkling with cheese.

### BEEF BROCCOLI

- 1/2 lb. beef (thinly sliced)
- 1/2 tsp. soy sauce
- 1 tsp. rice wine
- 1 tsp. cornstarch
- 1 1/2 cloves garlic (minced)
- 1/2 tsp. sugar
- 1/2 lb. broccoli (cut)

Mix all ingredients in a bowl and add to sliced beef. Marinate for 1/2 hour. Fold up beef in a sheet of foil. Place the package on rack. Add 1 cup of water into the glass pot. Turbo-steam at 325 deg.F for 10 minutes.

Open up the package, add broccoli flowerettes. Turbo steam for another 6-8 minutes.



### FOIL WRAPPED CHICKEN

- 1 lb. boneless chicken (sliced)
- 1 tsp. rice wine
- 1 tsp. sugar
- 1 1/2 tsp. cornstarch
- 1/4 tsp. ground pepper
- 1 clove garlic (minced)
- 1/4 cup soy sauce
- 1 cup carrots (sliced)
- 1 cup fresh mushrooms (sliced)
- 1/4 cup broccoli
- 1/3 cup cauliflower

Mix cornstarch with sliced chicken. Mix together other ingredients and add to chicken. Marinate for 2 hours in refrigerator, or 1/2 hour at room temperature.

Place mixed vegetables in the center of one sheet of foil. Place chicken on top of vegetables. Wrap up the foil paper. Place folded package on the rack. Turbo-bake for 20 minutes at 350 deg.F.

### GRILLED FISH WITH MISO (Japanese Gyoden)

- 1 whole mackerel
- 3 tsp. miso
- 2 tsp. water
- 2 tsp. sugar
- 2 tsp. mirin wine

Cut mackerel into 1" thick pieces. Mix miso with water and remaining ingredients to become miso pastry.

Turbo-grill the mackerel pieces at 350 deg.F for 5 minutes. Spread miso pastry on both sides of mackerel. Cook for another 4-6 minutes.

Mirin wine can be substituted with same amount of sugar and sherry.

### STEAMED EGG CUSTARD (Japanese Chawan-Mushi)

- 4 eggs
- 1 tsp. mirin
- 1/2 tsp. soy sauce
- 4 oz. chicken (thinly sliced)
- 4 pcs. black mushroom (water soaked)
- 4 prawns (shelled)
- 4 oz. fish (shredded)
- 2 oz. peas
- 1/2 tsp. salt

Beat the eggs well and mix with salt, mirin and soy sauce. Divide the chicken, mushrooms, prawns, fish and peas equally between 4 fireproof cups. Cover with the egg mixture. Turbo-steam at 350 deg.F for 15-20 minutes.

Mirin is sweet wine. It may be substituted with 1 tsp. sugar added to 1 tsp. sherry.

## FRUIT PIES

Use ready-made frozen pie crusts that come in pairs. These are packaged in disposable aluminum pie pans about 9 in. diameter which is just right for the 12-inch glasspot.

For a homemade touch, follow the directions on baking the 2-pie crusts, however precooking of the bottom crust for 400 deg.F, 5 minutes in the low rack gives a more crunchy crust that will not soak and become pasty with a fruit filling. When bottom crust is warm, brush with 1 tbsp. butter.

For the fruit pie fillings, it is handy to use canned ready mixtures. For a fuller pie, add the fresh or frozen fruit pieces of the same variety as the canned fruit filling. FOR EXAMPLE: slices of baking apple to pie filling. Dot with butter and sprinkle with cinnamon PLUS a tsp of lemon juice and 1/4 cup brown sugar.

Another example is adding fresh blueberries to a can of blueberry ready filling. Or, for the cherry pie filling, dot with more drained Maraschino cherries.

Add frozen sliced peaches for peach pie fillings.

## BANANA CREAM PIE

Use a ready mix of banana pudding and prepare according to package. Meanwhile, pre-bake one frozen pie crust for the bottom shell (turbo-bake, low rack, 400 deg.F, 6 mins.)

Slice fresh bananas into white sugar dissolved in 1/4 c water and 1 tsp. lemon juice is mixed (to prevent discoloration). Blend the cooked pudding gently to distribute banana slices. Cover with meringue and turbo-bake; 400 deg.F, for 5 minutes. (Or use ready- to-eat whipped cream).

## JIFFY VERY BERRY MUFFINS

Use a 7-oz package of ready mix blueberry muffins. Follow directions on the label for mixing. Use papercup linings for muffin pan. Add a tbsp. of blueberry pie filling (canned) at the bottom of paper cup before filling 2/3 full with the muffin batter. top with a few pieces of the whole blueberries and turbo-bake at 400 deg.F for 12 minutes on low rack.

## HIGH FIBER APPLE CUPCAKES

In a mixing bowl, blend 1/2 cup cooking oil, 2 eggs and 1 cup sugar. Sift together the following dry ingredients: 1 1/2 cup cake flour, 1/2 tsp. salt, 1/2 tsp. baking soda, 1 tsp. cinnamon, 1/2 tsp. nutmeg, and 1/2 tsp. baking powder.

Blend all dry ingredients with the first mixture. Add 1/4 cup raisins, 1/2 to 3/4 cup chopped walnuts, and 2 cups finely chopped red apples UNPEELED. (While chopping apples, add 1/2 tsp. lemon juice). BAKE: 350 deg.F for 20 minutes.

### LEMON SQUARES OR BARS

1 stick of butter (1/2 c)	1 cup sugar
1/4 cup powdered sugar	1 tsp. grated
2 large eggs	lemon peel
1 1/4 cups flour	3 tbsp. lemon juice
	1 tsp. baking powder

Cream the butter and powdered sugar until fluffy. Add half of the flour and beat well. Spread mixture on well-greased shallow cake pan and turbo-bake at low rack for 10 minutes, 350 deg.F or until nicely brown.

Mix remaining flour and baking powder. Beat eggs until light and add the granulated white sugar. Continue to beat; add lemon juice and peels alternately with the remaining flour and baking powder mix.

Pour the lemon mixture over the baked crust. Continue to bake 15 minutes or until done (slightly moist, not dry.) Remove from oven and sprinkle with powdered sugar. COOL before cutting into squares (or rectangular bars).

### FORTUNE COOKIES

3 tsp. cornstarch	3 egg white
1/2 cup sugar powder	1/2 cup vegetable oil
1/4 tsp. salt	1/5 cup water
1 cup cake flour	1 tsp. vanilla extract
Paper written fortunes	

Beat together egg whites, vegetable oil, water and vanilla extract in a large bowl. In a separate bowl, combine cake flour, cornstarch, sugar and salt.

Mix egg mixture with dry ingredients in a large bowl until smooth. Put foil paper on the rack and lightly oil the surface. Spread batter with spoon to a 3.5-4" round.

Turbo-bake 8-10 minutes at 300 deg.F or until light brown to form thin wafers. While still warm and pliable, top each wafer with fortune paper. The wafer is then folded in half and bent on the edge of a bowl.

To keep folded fortune cookies in shape, place them in a muffin pan.

### OTHER BAR COOKIES

For brownies, peanut butter cookies, chocolate chip or nut-oatmeal-raisin bars, etc. Ready mixes are very handy to use. Instead of forming into drop, smaller cookies; spread mixture on a greased disposable aluminum pan and bake on low rack of turbo-oven. FOLLOW TIME OF COOKING FOR REGULAR COOKIES, BUT LOWER TEMPERATURE TO LESS THAN 50 DEG.F.

## B. TURBO-BROILING AND TURBO-GRILLING:

### HELPFUL HINTS

To "broil" is to cook directly by radiant heat on a grill over live coals, or the broiling unit may be on top of the food to be cooked as in the case of a gas broiler, electric oven or convection oven.

The principle is to sear the surfaces and seal in the juices as quickly as possible, hence the use of high temperatures.

Food is placed directly on the grill or rack without covering. In turbo-broiling, the high rack is used to bring the food closer to the source of heated air. For that smoky flavor, a liquid smoke may be used (such as mesquite or hickory liquid smoke). This is applied on the surfaces of the meat along with the desired seasonings.

If the meat or fish is very lean, brush the grill or rack with cooking oil or spray with non-stick vegetable oil before arranging the meat/fish on the grill.

For thinner pieces, there is no need to turn, but for thick meat chops or steaks, broil on both sides.

The temperature of broiling is between 400 to 500 deg.F. In AeroMatic Oven, there is no danger of a smoky fire. Also, food is evenly browned and cooked inside.

Cooking time varies with the kind and size of the food, tenderness of the meat, thickness of the slices, amount of fat, whether marinated or dry, thawed out or frozen, pre-cooked or raw, etc. Just like any

cooking method, "Experience is the best teacher" and we encourage you to jot down your findings on the blank spaces of this book.

Turbo-grilling with the AeroMatic Oven is the healthiest way to grill as there is no smoke produced. Inhaling the smoke produced by coal barbecuing or grilling may cause cancer.

One of the advantages of turbo-broiling is the excellent glazing effect on a variety of products. Set the food either on low or high rack or about 4 inches away from the top heating unit. Apply the desired glaze and broil (400 to 475 deg.F) until the desired brownness.

Examples of glazed products:

Honey-glazed ham, ribs, roast chicken, roast pork

Glazed sweet potatoes, banana-Q (cooking plantains), rice cake with coco-honey topping, carrots.

Fruit jams/preserves or jellies work as a glaze for many broiled or roast meats.

### COUNTRY STYLE SPARERIBS

1 rack (3 to 4 lbs) pork spareribs cut into individual pcs.

MARINATE IN THE REFRIGERATOR OVERNIGHT WITH:

1/2 cup barbecue sauce

- 2 tbsp. honey
- 2 tbsp. Worcestershire (or soy sauce)
- 1 tsp. minced garlic
- 1 can beer or 1 non-cola soft drinks (lemon-lime, sprite, or ginger-ale)
- salt and pepper to taste

Turn ribs occasionally to be sure all parts are absorbing marinade.

**DRAIN RIBS AND TURBO-BROIL DIRECTLY ON LOW RACK.**  
Cook at 400 deg.F for 12-15 minutes.

#### **VARIATIONS:**

Save the juices drained from canned or bottled fruits such as canned fruit cocktail, peaches, pineapple and use instead of beer or soft drinks. Add liquid smoke of your choice. One cup of sherry for the liquid is an excellent alternative.

Instead of the bottled barbecue sauce, use left-over sweet and sour sauce.

Marinating another day in the refrigerator is even better. Use teriyaki sauce for soy sauce. If in a hurry, marinate for a few hours at room temperature.

### **PEPPER STEAK**

- 4 steaks (New York or T-bone)    1/4 tsp. dry basil
- 2 tbsp. ground pepper            1/4 tsp. garlic salt

Sprinkle pepper over both sides of each steak; press into surface. Sprinkle with basil and garlic salt. Let stand at room temperature for 20 minutes. Place steaks on rack and grill for 8-10 minutes at 400 deg.F.

### **GARLIC NEW YORK STRIP**

- 4 lbs. trimmed New York strip (boneless loin)
- 2 cloves garlic (minced)
- ground pepper

Combine garlic and pepper; rub over both sides of steak. Cover and let stand at room temperature for 1/2 hour. Place beef on rack and turbo-bake for 10-12 minutes at 400 deg.F.

### **TURBO GRILLED PRIME RIB**

- 6 lbs. prime rib bones, separated    1 clove garlic (minced)
- 1/3 cup dijon mustard                1/2 tsp. worcestershire
- 2 tbsp. red wine vinegar            1/4 tsp. ground pepper
- 1/4 cup olive oil

Arrange bones in a large shallow pan. Mix rest of the ingredients in a small bowl and pour over ribs; turn to coat. Cover and let stand for

about 1/2 hour.

Lift prime rib bones from marinade. Arrange on rack and turbo-grill for 10-15 minutes at 400 deg.F.

### BROILED PORTUGUESE LAMB

6 lamb shoulder chops	1/2 tsp. salt
1 cup dry red wine	1/2 cup chopped onion
1/4 cup vegetable oil	1 tbsp. whole mixed pickling spice
1/4 red wine vinegar	4 whole cloves
2 cloves garlic (minced)	1/4 tsp. ground cloves

Place lamb in a shallow pan. Mix rest of the ingredients in a bowl and pour over chops. Keep in refrigerator for 4 hours or overnight. Place chops on rack and turbo-grill for 10-12 minutes at 400 deg.F

### TURBO-GRILLED PORK (VENEZUELAN STYLE)

4 lbs. boneless pork butt roast	1/4 tsp. pepper
1 large onion (chopped)	1/4 cup vegetable oil
2 cloves garlic	1/2 cup white vinegar
1 can(4 oz.)pimentos (drained)	1/3 cup chopped parsley

In a bowl, mix together all ingredients. Pour mixture over meat. Keep in room temperature for 1/2-1 hour. Place meat on rack and turbo-baked for 425 deg.F for 10-12 minutes or till well done.

### TURBO-BROILED TERIYAKI

Teriyaki is a popular Japanese dish coined from two words: teri meaning "to shine" or "to glow" and yaki meaning "to broil". AeroMatic Oven cooking is perfect for the busy family with easier clean-up.

To prepare teriyaki sauce for marinating, mix the following: 1/4 cup soy sauce, 1/4 cup brown sugar, 1 tbsp. vinegar, 1/4 cup "mirin" (Japanese sweet wine), 1/4 cup "sake" (Japanese rice wine).

#### MEATS TO BROIL:

Fresh tender cuts of lean meats are preferred. There are many choices such as pork chops, beef steaks, chicken, tenderized "fajitas" or carabeef, turkey breast, and fish. Of the fish and seafood, favorites are split squid, lobster, prawns, fish fillet or fish steak.

#### METHOD:

Marinate meat or fish turning the pieces occasionally for uniform soaking. Meats are best marinated overnight in the refrigerator or for several hours at room temperature. Fish needs only an hour for marinating. Drain and broil.

TURBO-BROIL AT HIGH RACK FOR THIN SLICES AND AT LOW RACK FOR THICKER PIECES. (475 deg.F). Time varies with kind of meat or fish used. Baste or brush with marinade two times while cooking. Broiling time may range between 8 and 30 minutes.

NOTE: Teriyaki sauce is available ready to use from a bottle instead of making your own. If meat or fish is on sale, have your grocer slice or fillet for you so that all you have to do is marinate and then divide into portions for a meal. Freeze some for future company. **SERVE WITH FRESH GREEN SALAD, TOMATO, AND STEAMING HOT RICE.**

### **BROILED DRIED FISH (Philippines) ("Inihaw na Daing")**

"Daing na isda" or dried fish is usually bought as such cello-packed from the Asian countries. The fresh fish like a "butterfly" and heavily salted in the absence of cold storage. The salted fish is sundried until it is dry to the touch.

"Daing" is usually fried in cooking oil, but it is smokey and smells up the house. To avoid these disadvantages, we recommend turbo-broiling and cooking in an open shed or in your open garage. If the weather is nice, you can cook on top of a table in your back yard.

The dried fish may be washed first to remove excess saltiness before grilling. Brush with cooking oil if desired.

"Tuyo" which literally means "Dried" refers to the "tunsoy" or herring type of small fish. "Tinapa" is a smoked fish usually with scales on and dyed with an oily coloring (golden brown). It is not too dry and is usually frozen or refrigerated. These preserved fish are also grilled, broiled or pan-fried. Dried squid or "pusit" is one of the famous appetizers in the Philippines.

### **NATIVE LONGANIZA AND HOT DOGS**

Prick with a table fork several times around the Philippine sausages or hot dogs (franks) before setting directly on the high rack. Grill for 5 minutes at 475 deg.F without turning. For larger diameters as in jumbo hot dogs, allow a few more minutes to cook. **NO NEED TO STEAM OR PAN-FRY**, as usually done on top of the stove. Excess fat is removed from the longaniza and there is no spattering!

### **GRILLED BACON SLICES**

Arrange in a single layer directly on the mesh or screen like pan. Broil at 475 deg.F until the desired crispness.

### **GRILLED FAJITAS (Skirt Steak)**

Fajita meat has been in demand within the last few years. The word is derived from the Spanish "faja" or belt because this meat cut comes from the supporting part covering the diaphragm of the cattle.

Fajita is pounded thinly and then marinated overnight. Marinade consists of 2 tbsp. soy sauce, 2 tbsp. Worcestershire sauce, onion salt and pepper to taste, and the juice of one lime ("dayap") for every 3 lbs. of fajita meat. Be sure meat is not over 1/3 of an inch thick. Slice the meat thinly across the grain of the meat and served with Picante sauce, folded into warm flour tortillas. Grill at high temperature for a short time (475 deg.F, 5 mins.)

### GRILLED LAMB CHOPS

Rub on both sides of 4 lamb chops: garlic salt, 1 tbsp. mint jelly, and 2 tbsp. cider vinegar. Set aside for an hour before grilling at 400 deg.F for 7 minutes. Since lamb chops are lean, spray surface with vegetable oil or brush with cooking oil.

### GRILLED HAM SLICES

Cut baked ham into 1/4 inch slices. Glaze with honey or dark brown sugar and grill until sugar is almost caramelized. (400 deg.F, 8 to 10 minutes each side)

### HAMBURGERS

Form patties to fit the size of your buns. At 400 deg.F grill for 8 mins. or to desired doneness and add a slice of cheese on top for a cheese-burger. Seasonings may be mixed into the ground lean chuck or round before grilling. Some prefer to mix in chopped onions rather than as a topping. If hamburger patties are frozen, there is no need to defrost.

### GRILLED CHEESE DOGS

Make a lengthwise slit, halfway through the franks or hot dog. Insert cheese slices before grilling. Buns may be warmed or toasted over grill.

### GRILLED FISH STEAKS

Fresh salmon steak, halibut, haddock, or other lean meaty fish will need cooking oil (zero cholesterol) on its surface before grilling. Broil at 475 deg.F for 5 to 8 minutes. REMINDER: Do not place on a pan and do not cover. Otherwise, it will be baked or steamed rather than broiled!

### SPECIAL POLYNESIAN BROILED CHICKEN

MARINATE WHOLE FRYER (3-4 lb) with:

1/2 cup cooking sherry (or rum)	1/2 cup brown sugar
1/2 cup barbecue sauce	(or 2 tbsp.molasses)
1/4 cup soy sauce	1/2 cup pineapple juice
1 tbsp. minced fresh ginger	4 small pineapple rings
root	

After several hours, drain and seat on low rack. TURBO-BROIL for 30 minutes at 475 deg.F. Place the pineapple rings on top and baste with the marinade, then continue to cook for another 10 minutes. Serve golden brown chicken with your favorite sauce.

Meanwhile, thicken the drained marinade with cornstarch or All Purpose flour on top of your stove under simmering temperature. Add some vinegar, other spices and catsup to suit your taste. Serve golden brown chicken with this sauce or another favorite sauce.



### CORN-IN-THE-HUSK

Choose fresh corn in husks. Peel back husks on each ear of corn. Remove corn hair, spread with margarine. Pull husks back up around corns. Tie tops closed with string. Place corn on rack. Turbo-grill at 400 deg.F for 15-18 minutes. To serve remove husks from corn and sprinkle with salt.

### NEW LONDON BROIL WITH LEMON-BUTTER GRAVY

Ask the butcher shop to prepare LONDON BROIL cuts. This is usually beef flank steaks with criss-cross slits on both sides of the meat. Marinate for one hour in the following (Good for 2 1/2 to 3 lb flank steaks):

2 tsp. lemon juice	1 tsp. onion salt
1 tsp. garlic salt	3 tbsp. cooking oil
1/4 tsp. black pepper	2 tbsp. water

DRAIN AND TURBO-BROIL ON HIGH RACK PLACING THE MEAT DIRECTLY ON THE RACK (about 4 inches away from top cover.) Cook 5 minutes at 475 deg.F turn and cook a few more minutes on the other side.

SERVE WITH LEMON-BUTTER GRAVY SLIGHTLY THICKENED WITH FLOUR AND SIMMERED UNTIL DONE (cook on top of your stove.)

### BROILED EGGPLANT

Wash eggplant and prick with table fork around surface about 6 - 8 times. Broil in low rack at 475 deg.F for 15 mins. turning it once after 6-7 minutes. These conditions are good for the long oriental variety sometimes called Japanese eggplant which has the dimension of an average eating banana. The skin of this variety when fresh is usually purple or violet and can be made into delicious individual stuffed eggplant or eggplant omelet.

The bigger and rounder eggplant, which is usually available in your local supermarket, is split lengthwise and broiled with the cut part facing the rack. It will take longer to cook. The bigger broiled eggplants are excellent for mashing to prepare the eggplant sauce for "POCHERO" dish or as a side dish of sliced eggplant and vinegar-garlic-salt sauce with fresh tomatoes to accompany fried or broiled meat and fish main dishes.

Turbo-broiled eggplants retain the nutrients and juice with even cooking. The skin is easily peeled and the pulp is not discolored.

### BROILED BELL PEPPERS

Broil whole bell peppers (Spanish peppers) about 12 minutes on the low rack (475 deg.F) or until skin just separates from pulp. Leave the peppers whole: do not prick.

Stuff with your favorite fillings such as rice-ground beef tomato mixture.

### **BROILED CORN ON THE COB**

Unhusk and remove hairy pieces of fresh corn on the cob. Place directly on low rack. For the average length corn cob, one-time broiling can accommodate 5-7 ears.

Turbo-broil at 475 deg.F. The cooking time is about 30-40 minutes, depending on maturity and diameter of corn cobs.

### **BROILED STUFFED MUSHROOMS**

Select large uniform sizes of fresh mushrooms. Wash well and remove the stem leaving the hollow head for your favorite stuffing.

Place in shallow pan and set on the high rack. Broil at 400 deg.F; (cooking varies with stuffings.) Size of mushrooms and amount of filling/toppings will vary cooking time from 5-10 mins.

### **RED PLUM GLAZED LEAN PORK OR TURKEY BREAST**

Boneless turkey breast (3 pcs) or 2 lb. pork roast. Season surfaces with lemon juice, garlic salt and pepper. Place on a shallow pan and set on the low rack. Roast at 400 deg.F for 20 minutes. In the last five minutes of cooking, spread to glaze with a small jar of red plum preserves. Whole roast turkey may not fit the 12 in. diameter x 7 in. high pot. However, a deep stockpot may be used. Be sure to use hot stand to protect table counter.

### **C. TURBO ROASTING:**

#### **\*HELPFUL HINTS**

Roasting is a dry-heat method of cooking big pieces of meat uncovered on a rack, with or without a supporting pan. When cooking, be sure that your roast will not touch filter.

Line the bottom of the glass pot with aluminum foil with an inch of rim like a pie pan to catch drippings. **USE LOW RACK AND LET HOT AIR FREELY CIRCULATE.** The propelled hot air seals in the juice and cooks meat evenly. There is no need to preheat, baste or turn.

A meat thermometer is recommended, but in its absence, follow the time-temperature on page 37. Or, follow the chart given for regular or conventional ovens **EXCEPT THAT THE TEMPERATURE FOR TURBO-ROAST IS 50 deg.F LOWER.**

**TIME OF ROASTING VARIES WITH:** kind of meat (beef, pork, lamb, etc.) type of cut (shoulder, with or without bone, loin or rump, etc.), amount of fat and tenderness according to age or maturity of animal. The thickness and weight of each piece has to be considered also.

**A LONGER COOKING TIME IS REQUIRED FOR FROZEN OR PARTIALLY THAWED OUT MEATS.**

**LASTLY, DEGREE OF DONENESS FOR BEEF VARIES WITH EACH PERSON. HOWEVER, PORK MUST BE ALWAYS WELL-DONE.**

IF MEAT IS LEAN, SPRAYING THE RACK AND THE SIDE OF POT WITH NON-STICK VEGETABLE OIL OR BRUSHING WITH OIL FACILITATES REMOVAL OF MEAT.

"BROASTING" is a term coined from the combination of broiling and roasting. The AeroMatic Oven is perfect for this method. Either broiling or roasting can be done first, depending on personal preference. For example, to seal in the juice of beef steaks or roast, broil at high temperature (475 deg.F) for about 5 to 10 minutes according to size of meat. Then finish cooking by roasting. But if you like a crispy and nicely brown crust/surface, roast first and broil last.

### WHOLE ROASTS

Place whole meat directly on the low rack, with the fatty portion facing the heating top unit. Baste seasoning all over the surface as desired. Insert meat thermometer into the middle thick part without hitting bone. The temperature for Turbo roasting is generally 50 deg.F less than regular oven or conventional roasting. It takes less time, too, yet the interior is done and juicy. The juices are sealed in and there is no need to baste. Cooking time depends on kind of roast and size.

In the absence of a meat thermometer, use the following table on next page as guide:

IN ALL THESE ROAST MEATS, SET TEMPERATURE AT 400 DEG.F.

KIND OF MEAT	WEIGHT FOR ROUND GLASSPOT	APPROX.TIME
	(lbs.)	(minutes)
BEEF, RIB ROAST RUMP or CHUCK	2 to 3	RARE: 15 to 20 MED.: 20 to 25 WELL: 25 to 30
BEEF, BONELESS WHOLE ROAST	2 to 3	RARE: 15 to 20 MED.: 20 to 25 WELL: 25 to 30
PORK, PICNIC	2 to 3	WELL: 25 to 30
PORK, LOIN (boneless)	2 to 3	WELL: 20 to 25
,LOIN w/bone	2 to 3	WELL: 25 to 30
PORK RIBS	2 to 3	WELL: 20 to 25
HAM w/bone & FULLY COOKED	2 to 3	MED.: 12 to 15

### ROAST WHOLE CHICKEN

Wash the fryer or roaster in and out and rub with spices/condiments desired. A simple seasoning quickly applied is an all-seasoned salt mixture, as purchased from your grocer. Or for the plainer taste, garlic, salt and black pepper. Let seasonings penetrate a few hours (preferably overnight in the refrigerator) before roasting. Line bottom

of pot with aluminum foil to catch drippings (not on top of the low rack!). Roast at 400 deg.F for about 10 minutes per lb. If a crispy skin is desired, increase temperature to broil (475 deg.F) for an additional 5-10 minutes.

### **CHICKEN BARBECUE**

After marinating a quartered chicken with your favorite sauce, roast with skin 20-30 mins. on low rack at 400 deg.F. **BROIL LAST 5 mins.** for browner skin. Cut-up chicken parts will take a shorter amount of cooking time.

### **STUFFED WHOLE CHICKEN**

Clean a 5 lb. fryer/roaster and pat-dry before seasoning. Fill cavity with desired stuffing mixture and rub outside parts with your favorite spices and condiments. **ROAST** with breast part up on low rack without a pan (but catch drippings with aluminum foil lining on bottom of pot). Allow 15 mins/lb to be sure stuffing is done, at 400 deg.F.

### **ROAST CORNISH HEN**

With this smaller poultry, 3 whole pcs. can be roasted directly, seated on the low rack. Season as desired and roast for 25-30 minutes at 375 deg.F.

### **GOURMET STUFFED CORNISH HEN**

Follow above recipe. Before roasting, stuff cornish hen with rice stuffing recipe below:

On top of stove, fry 1 cup of rice in 2 tsp. butter or oil until golden brown. Add cut-up onions, 1 tsp. garlic salt and 1/8 tsp. black pepper.

Add diced chestnuts, (or almonds) celery and 1/2 cup white or sherry wine. Add 1 cup water and simmer for 30 minutes or until rice is tender but not overcooked.

#### D. AeroMatic Oven™ AS A TOASTER AND WARMER:

Toasting bagels, croissants, slices of bread, French rolls, brown and serve dinner rolls, garlic bread, etc. using the AeroMatic Oven saves time (no preheating), and yet the quality of the product is excellent. The crust is crispy, and the inside is moist and soft.

Unlike re-heating in a microwave oven, one can reheat or warm up a previously cooked baked product without the risk of a gummy (not crispy) or tough product, as long as when the first cooking was done with the AeroMatic Oven.

Toasting sesame seeds, almonds and other nuts, small dried fish, using the AeroMatic Oven yields uniform browning WITHOUT STIRRING.

Use rack: temperature is regulated between 350-400 deg.F and cooking time may vary from 5 to 15 minutes, depending on the surface area and moisture content of food item. The see-through glass pot is useful in this case. HOWEVER, BECAUSE OF THE PROPELLED AIR, light food items may move around. To avoid this, cover with a wire mesh. The author has used the "spatter preventor" or grease safety lid sold in many stores with the handle cut off.

NOTE THAT TOASTED FRENCH BREAD AND GARLIC BREAD toasted in the AeroMatic Oven remains crusty for several hours. Mooncakes and pastries, croissants, pie crust, are best heated in AeroMatic Oven with the flaky, crunchy crust which does not become soggy or gummy when it cools off.

STALE NACHO CHIPS, POTATO CHIPS, CRACKERS, NUTS AND COOKIES CAN BE FRESHENED UP IN THE SUPER TURBO OVEN A FEW MINUTES AT HIGH TEMPERATURE. Allow to cool to restore crunchiness (when hot, product is not yet crispy).

### **E. TURBO-FRYING-a healthy way of cooking**

This method of frying has the following advantages:

1. Little or no fat is used, yet the effect is like panfrying or deep-fat frying.
2. Useful for fat and cholesterol restricted diets.
3. Food is uniformly browned even without turning on the other side for most thin items.
4. Exterior is crusty or crisp and interior is done but moist. For e.g.: turbo-fried chicken has crispy skin or exterior, but inside, the meat next to the bone is not rare. Meat is juicy and tender.
5. After frying, the product does not sog or limp, but stays crisp because there is no fat absorption as with foods which have been deep-fat fried.
6. No spattering and no need to watch to avoid any accidental fire caused by overheated fat.
7. Pan is easy to clean after cooking. In turbo- frying, sticky drippings as well as the extra oil or fat can be captured in an aluminum foil lining at the very bottom of the pot (not over the rack).
8. Because the temperature is controlled at not over 450 deg.F in turbo-frying, the oil does not heat up to an undesirable brown smokey fat.

9. Summing it up: Turbo-frying takes less time and energy and cheaper too, since cooking oil for deepfat frying is expensive. ABOVE ALL, IT IS A HEALTHIER WAY OF FRYING!

### **GUIDELINES TO PROPER AeroMatic Oven-FRYING**

1. Use a rack to allow free circulation of hot air. Spray the rack with a non-stick vegetable oil OR brush surface or rack/strainer with non-cholesterol cooking oil. THIS WILL FACILITATE REMOVAL OF COOKED FOOD.
2. Temperature and cooking time varies with the size and kind of food.
3. NO PREHEATING. Unlike deep-fat frying where the cooking oil must be hot enough before dropping the food to be fried.
4. In AeroMatic Oven-frying, a thin layer of oil should be evenly distributed on food with the aid of a pastry brush.
5. At the end of AeroMatic Oven-frying, remove the top heating unit at once and remove cooked food to cool, as it will become crispy faster. If you let the oven top cover the pot, the steam will cause the food to become soggy instead of a dry crisp turbo-fried product.

## FRENCH FRIES

Spread on the wire-basket or screen a single layer of frozen French fries straight from the package. NO DEEP-FAT FRYING! Most frozen French fries have some shortening added to them prior to freezing.

Set the strainer or screen mesh on the rack. Turbo-broil at 400 deg.F for 10-12 minutes. The effect is crisp evenly browned fries without fat-frying. Think of the savings in time-energy, cleaning up and most of all, the wasteful use of cooking oil in deep-fat frying.

## LOW CHOLESTEROL FRENCH-FRIED POTATOES

Wash and brush 6 white medium-sized potatoes. Cut into strips and pat dry with a paper towel. Roll each strip in poly-unsaturated oil and place strips in single layer on meshed rack. Bake at 475 deg.F for approximately 30 minutes or until golden brown.

Substitutes can be sweet potatoes or yams.

## SOUTHERN FRIED CHICKEN

Cut chicken fryer into quarters. Marinate in 1 cup of milk, tsp. garlic salt, and black pepper for fifteen minutes. Shake in a brown paper bag with 1 cup flour and 1/2 tsp. paprika, covering chicken liberally with flour. Roll flour covered chicken in poly-unsaturated oil and bake at 300 deg.F for 20 minutes and at 475 deg.F for 5 - 10 minutes or until golden brown. Longer if crispier fries are desired. Remove from super turbo immediately to avoid steaming.

## HOME-MADE EGG ROLLS (OR SPRING ROLLS)

Egg rolls are made from thin skin of unraised dough, wrapped around various seafood, meats and vegetables. Originated from Canton, China, they were served as snacks with tea when friends and relatives came to visit after Chinese New Year in early spring. They are also known as spring rolls.

Egg rolls are usually deep-fried. It is easier and faster to cook eggrolls, when using AeroMatic Oven. Purchase ready-made roll skins from grocery store. Prepare the following fillings:

- 6 dried black mushrooms (soak and cut in thin strips)
- 1/4 lb. chicken breast (cut in thin strips)
- 6 water chestnuts (chopped)
- 1/4 lb. shrimp (shell and mince)
- 1 lb. bean sprouts
- 1/2 cup bamboo shoots (shred)
- 3/4 tsp. garlic salt
- 1/2 tsp. sugar
- 1/4 tsp. ground pepper

Combine chicken, shrimp and vegetables with remaining ingredients and mix well. When ready to turbo-fry, place vegetable oil on a shallow pan or dish. Roll each egg roll quickly to cover its surface with a thin film of oil. Place on high rack and turbo-fry at 400 deg.F for 15-20 minutes. For more crispier, browner skin, use turbo-broil at 450 deg.F for additional 3-5 minutes.

### COOKING FROZEN FOOD:

Another advantage of the AeroMatic Oven is its ability to cook from frozen state (without thawing) any meat, fish or frozen foods. Just allow a longer cooking time, depending on size, shape, composition of the food, added ingredients, etc.

For frozen convenience products like TV dinners, French fries, pizzas, muffins, meat-vegetable pot pies, breaded fish fillet/sticks, casserole dishes (meat- noodles, vegetables with sauces, etc.), the frozen food or meal in its original packing is placed directly on the low rack and safely heated. Simply follow directions on the label for regular or conventional oven, BUT REDUCE COOKING TEMPERATURE BY 50 deg.F. Cooking time may take 5 to 10 minutes shorter for some products. NO PREHEATING PERIOD!

### **BAKING TV DINNERS**

Cooking frozen TV dinners in the AeroMatic Oven is safe and convenient. Note that the label on some TV dinners state "DO NOT USE IN TOASTER OVEN". With the AeroMatic Oven, just follow the directions given for a regular or convection oven, EXCEPT THAT use the low rack and set temperature 50 deg.F lower! Some dinners also cook for 5 to 10 minutes less. Again, by experience, even with one trial, the time-temperature for doneness can be adjusted for future cooking of a particular or specific kind and brand of TV dinner.

The following are examples:

---

#### KIND OF TV DINNER CONVENTIONAL OVEN AeroMatic Oven

---

Meat Loaf w/ potato nuggets, green beans & apple crumb	Preheat 10 mins. (350 deg.F) Then bake at 350 deg.F, for 30 mins.	No preheating! Bake @ 300 deg.F for 20-25 mins
Swedish Meatballs w/ noodles and cream sauce	Preheat 10 mins. (350 deg.F) and bake for 20 mins.	No preheating! Bake @ 300 deg.F for 15 mins.
Turkey Dinner w/ whipped potatoes, gravy, peas and apple-cranberry compote	Preheat 10 mins. (350 deg.F) Bake for 30 mins.	No preheating! Bake @ 300 deg.F for 25 mins.

---

### **PIZZAS**

For a short preparation time, buy frozen pizza but be sure diameter is about 10 inches to fit into the glasspot. Depending on the kind and amount of toppings, the commercial ready-made pizza can be further dressed up to your own taste.

Generally, one has to add more shredded cheese. Slices of bell peppers, ripe or stuffed olives, fresh mushrooms and extra Italian sausage rings or "chorizo bilbao" for that homemade touch. Add some



tomato sauce if topping appears dry.

**BAKE ON LOW RACK** at 450 deg.F for about 8-10 minutes. Place on the rack without a pan for a crisper crust.

## LIMITED WARRANTY

Aroma Housewares Company warrants this product free from defects in material and workmanship for one year from provable date of purchase in continental United State. Within this warranty period, Aroma Housewares Company will repair or replace, at its option, defective parts at no charge, provided the product is returned, freight prepaid with proof of purchase and U.S. \$6.00 for shipping and handling charges to Aroma Housewares Company. Please call the toll free number below for return authorization number. Allow 2-4 weeks for return shipping.

This warranty does not cover improper installation, misuse, abuse or neglect on part of the owner. Warranty is also invalid in any case that the product is taken apart or serviced by an unauthorized service station.

This warranty gives you specific legal rights and they may vary from state to state and does not cover areas outside continental United States.

AROMA HOUSEWARES COMPANY  
6469 Flanders Drive  
San Diego, California 92121  
1-800-276-6286  
M-F, 8:30 AM - 5:00 PM, Pacific Time